

HZ-3320B Transformer DC Resistance Tester



Dear user:

Thank you for choosing HZ-3320B Transformer DC Resistance Tester .

We hope that this instrument can make your work easier and more enjoyable, so that you can get the feeling of office automation in the test and analysis work.

Before using the instrument, please read this manual, and operate and maintain the instrument according to the manual to prolong its service life. "Just a light press, the test will be completed automatically" is the operating characteristics of this instrument.

If you are satisfied with this instrument, please tell your colleagues; if you are not satisfied with this instrument, please call (0312) 6775656 to tell you to serve you at all times-Baoding Huazheng Electric Manufacturing Co., Ltd., our company will definitely make you satisfied !

Contents

I.Overview	2
II. Safety Measures	2
III. Functional Characteristics	3
IV. Technical Indicators	4
V. System Introduction	5
VI. Test and Wiring Methods	6
VII. Tester Operation Methods	7
VIII. Notes	22
IX. List of Complete Accessories	22

I.Overview

The Transformer DC Resistance Tester is a mandatory test item for semi-finished products and finished products factory test, installation and handover test, and preventive test of the power department in the transformer manufacture industry. It can be used to effectively detect the defects in poor material selection, loose welding and connection parts, missing strands and broken wires of the transformer coil, as well as the operation hidden dangers. In order to meet the requirements of rapid measurement of transformer DC resistance, a large-scale power transformer DC resistance rapid tester integrated with Three-Phase simultaneous test function, Magnetic Augment Function, and Degauss Function into one body has been developed in our company. The tester has the functions of three-phase simultaneous power-on, independent current and voltage sampling, simultaneous measurement and display of three-phase resistance and three-phase unbalance rate, so as to greatly shorten the test period of transformer DC resistance and solve the problems about long time consumption for DC resistance measurement of each tap winding in power transformers.

II. Safety Measures

- 1) Must read this manual carefully before using the tester;
- 2) The tester operator should understand the common knowledge on general electrical devices or instruments;
- 3) The tester can be used indoors and outdoors, but it should be protected from rain, corrosive gas, excessive dust, and high temperature;
- 4) The tester is a precision instrument and any severe vibration must be avoided;
- 5) The tester should be maintained, repaired and adjusted by professionals;

- 6) After the test, be sure to wait for the discharge alarm to stop before turning off the power and removing the test wires;
- 7) When measuring the no-load voltage-regulating transformer, the tap changer can be switched only after the discharge indication alarm stops.
- 8) During the test, do not move the test clips and the power lines.

III. Functional Characteristics

- 1) The tester can select corresponding output current value according to test products, and is mainly suitable for measuring the inductive DC resistance on transformers;
- 2) On large transformers with a five-leg core and low-voltage windings connected in delta, the tester can be used for the test in HV & LV series excitation mode. The magnetic augment circuit of the windings can be automatically connected in the tester, to quickly and accurately test the DC resistance of the low-voltage windings;
- 3) The tester has a Three Phases Test function to measure the three-phase DC resistance of the star-connected windings synchronously and calculate the three-phase unbalance rate automatically, so as to greatly reduce the measurement period and improve the test efficiency. Its phase by phase test function can also be used for phase by phase test on transformers with YN and D (Y) connections;
- 4) The winding material can be set according to the winding material of the transformer, such as copper or aluminum, to distinguish the conversion temperature coefficient of different materials.
- 5) The tester is equipped with transformer YN winding neutral point lead line resistance detection function, can make three-phase test data closer to the single-phase test value.
- 6) The tester has a complete protection circuit and sound discharge alarm, to inform the clear discharge indication and reduce the misoperation;
- 7) The tester is equipped with a 7-inch color touch screen. to display the test data clearly in real-time;
- 8) The tester has Chinese and English operation interfaces, which can be configured

according to the user requirements;

- 9) The tester is equipped with a RS232 communication port, to transmit the test data to the background, with the control software in the host computer;
- 10) The tester is equipped with a USB port, to transfer test data into a U disk;
- 11) The tester has a built-in calendar and clock, as well as saving (save 100 groups of data), review, and printing functions of test data;
- 12) The tester has more complete parameter settings, including test windings, Tapping Positions, test phases, Tested Sample Temperature, Conversion Temperature and others of the transformers;
- 13) The tester is equipped with an industrial plastic case which ensures its good portability and improves its service life.

IV. Technical Indicators

- 1) Output current:

Three-phase test: 10A+10A; 5A+5A; 1A+1A; 200mA+200mA; 20mA+20mA;

Single-phase test: 20A; 10A; 5A; 1A; 200mA; 20mA;

- 2) Measurement range:

Three-phase test: 10A+10A: $1\text{m}\Omega\sim 0.6\Omega$;

5A+5A: $2\text{m}\Omega\sim 1.2\Omega$;

1A+1A: $10\text{m}\Omega\sim 6\Omega$;

200mA+200mA: $100\text{m}\Omega\sim 30\Omega$;

20mA+20mA: $10\Omega\sim 200\Omega$;

Single-phase test: 20A: $0.5\text{m}\Omega\sim 1\Omega$;

10A: $1\text{m}\Omega\sim 2\Omega$;

5A: $2\text{m}\Omega\sim 4\Omega$;

1A: $10\text{m}\Omega\sim 20\Omega$;

200mA: $100\text{m}\Omega\sim 100\Omega$;

20mA: $10\Omega\sim 20\text{K}\Omega$;

- 3) Accuracy: $\pm(0.2\%+2\text{ digits})$;
- 4) Minimum resolution: $0.1\mu\Omega$;

- 5) Operating temperature: -10~40℃;
- 6) Ambient humidity: ≤80%RH, no condensation;
- 7) Power supply: AC220V±10%, 50Hz±1Hz;
- 8) Tester dimensions: 428mm* 350mm* 230mm (L*W*H);
- 9) Tester mass: 11.2kg.

V. System Introduction

The operation panel of the tester is shown below



Fig. 1

- 1) **IA, IB, IC, IO terminals:** Current input terminals /output terminals for YN winding measurement;
- 2) **VA, VB, VC, VO terminals:** Voltage input terminals for YN winding measurement;
- 3) **Ia, Ib, Ic terminals:** Current input terminals /output terminals for D or Y winding measurement;
- 4) **Va, Vb, Vc terminals:** Voltage input terminals for D or Y winding measurement;
- 5) **Printer:** To print the resistance test results and other information;
- 6) **Display:** 7-inch color touch LCD screen, to display operation menu, test parameters and data records;
- 7) **Power switch and socket:** Including the main power switch and the 220V AC power socket of the whole machine;

- 8) **Grounding terminal:** It is used for grounding the whole machine case for grounding protection;
- 9) **USB port:** It is the port to connect the tester with U disk and used to export the test data from the memory;
- 10) **RS232 communication port:** It is the communication port between the tester and the host computer.

VI. Test and Wiring Methods

- 1) **Test wiring connections:** Connect the tested product to the test terminals of the tester with the dedicated test wires and the ground wire firmly. Clamp the wiring clips are at both terminals of the coil resistance of the tested product respectively. Connect the power wires on the tester to the AC power input ports and turn on the power switch to the LCD screen lights up.
- 2) **Test wiring classification on the two-winding transformer:** Connect the yellow, green, red and black test clips on the Yn winding of the tester to the A, B, C, O bushings on the star connection side of the transformer at one time, and then connect the yellow, green, and red test clips on the D (Y) winding of the tester to the a, b, and c bushings on the corner connection side of the transformer respectively, so as to complete the measurement connection, as shown below:

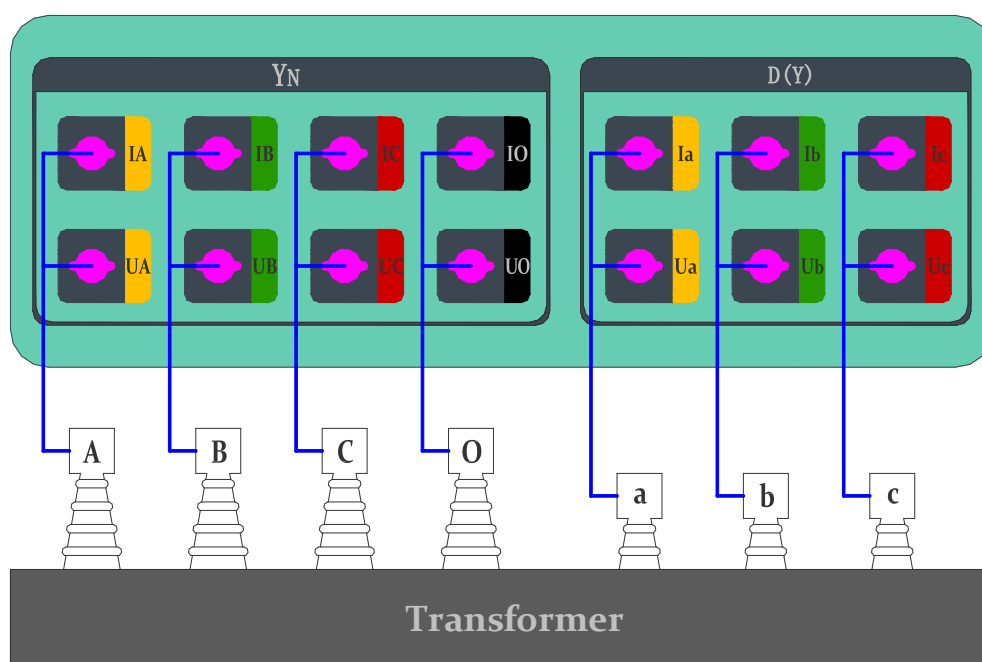

Fig. 2

3) **Test wiring on three-winding transformer:** After the HV and LV winding tests are completed, connect the test clips on the HV side to the MV side for testing.

VII. Tester Operation Methods

1) Boot interface

First, connect the test wires and power wires of the tester, turn on the power switch; in this case, the main menu interface will be displayed on the LCD screen, as shown below:

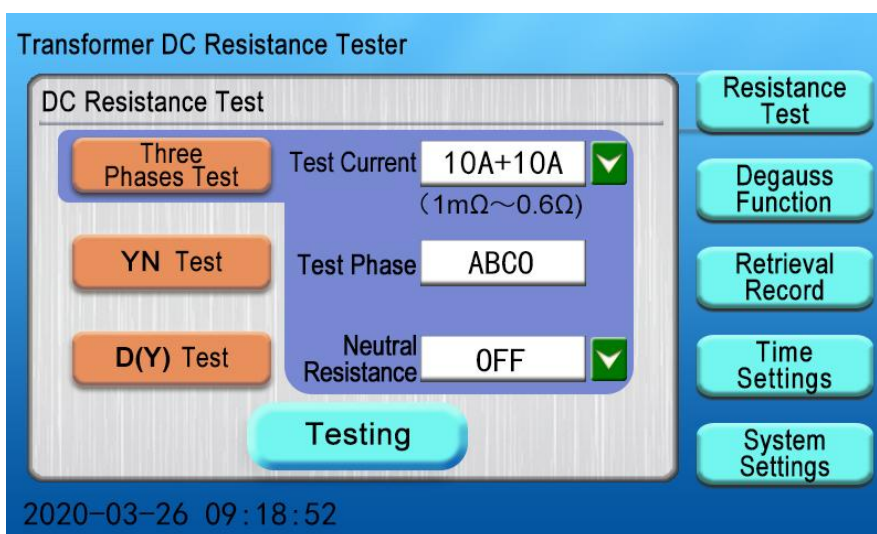

Fig. 3

On the main menu interface, the “**Resistance Test**”, “**Degauss Function**”, “**Retrieval Record**”, “**Time Settings**”, and “**System Settings**” menus will be displayed on the right side. If any menu is clicked, the corresponding parameters will be displayed on the left side (by default, the “**Three Phases Test**” item under the “**Resistance Test**” menu is selected on the main interface). Based on the actual wirings of the tester, you can operate the corresponding option on the LCD screen.

2) DC resistance test

(1) **Three Phases Test:** By default, the “**Three Phases Test**” item under the “**Resistance Test**” menu is selected on the main interface. You can click the button under the current option to change the test current, select the corresponding test current level for the tested product, and then click the “**Testing**” menu to enter the Three Phases Test interface and display the three-phase test current valued, as shown below:

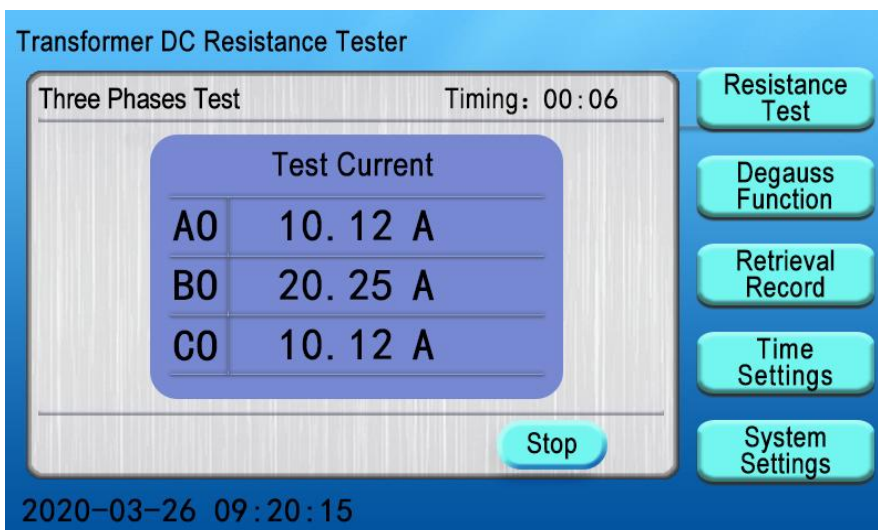

Fig. 4

Wait for a few seconds until the test current is stabilized; The instrument interface shows the value of the three-phase resistance and the unbalance rate of the three-phase resistance, as well as the converted resistance values at the set temperature will be displayed on the tester interface, as shown below:

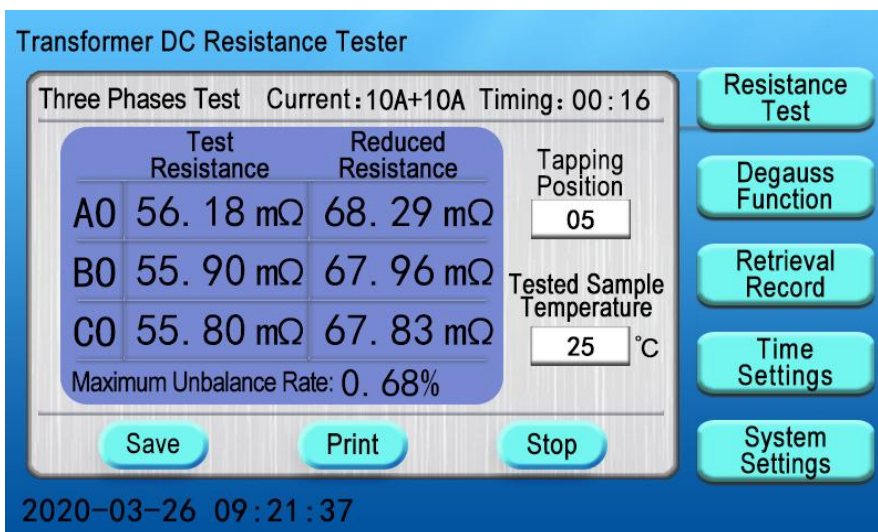

Fig. 5

During the test, you can click to change the values of the “**Tapping Position**” and “**Tested Sample Temperature**” parameters based on the actual test conditions; for example, you click the “**Tapping Position**” prompt box to display the numeric keyboard prompt box, enter the corresponding tap number and then click “**OK**” button for confirmation, and then click the “**ESC**” button to return to the test interface, as shown below:

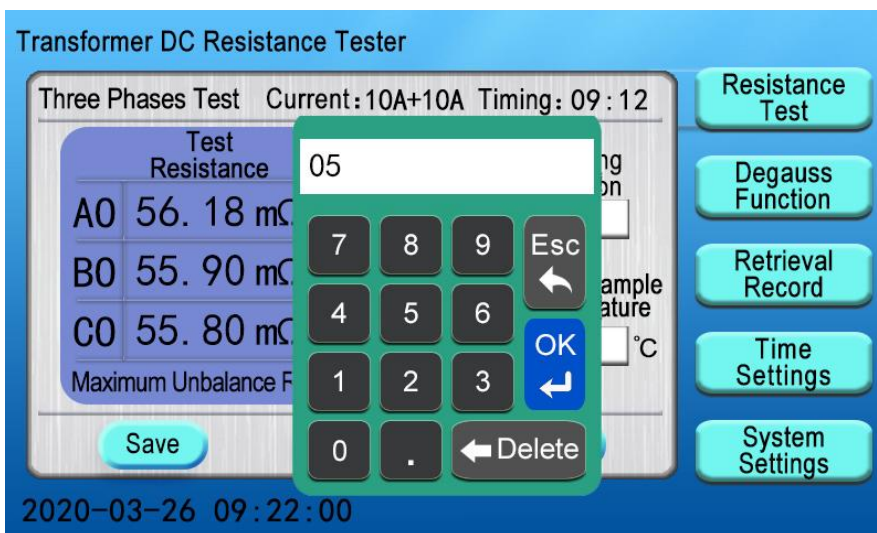

Fig. 6

After the test is completed, you need to save the current data. You can click the “**Save**” button; in this case, the “**Saving, Please Wait...**” prompt box will be displayed on the LCD screen, indicating that the test data is being saved. After a few seconds, the “**Save successfully**” prompt box will be displayed, indicating that the test data has been saved, as shown below:

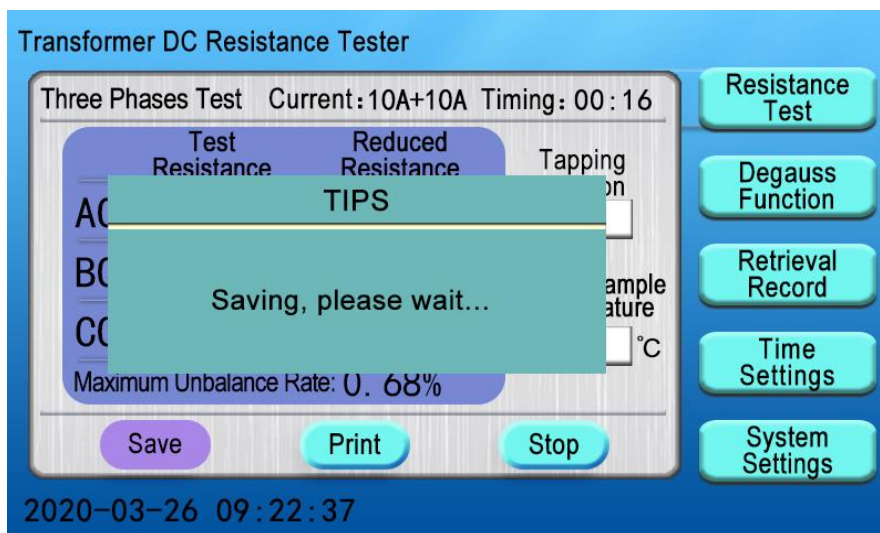

Fig. 7

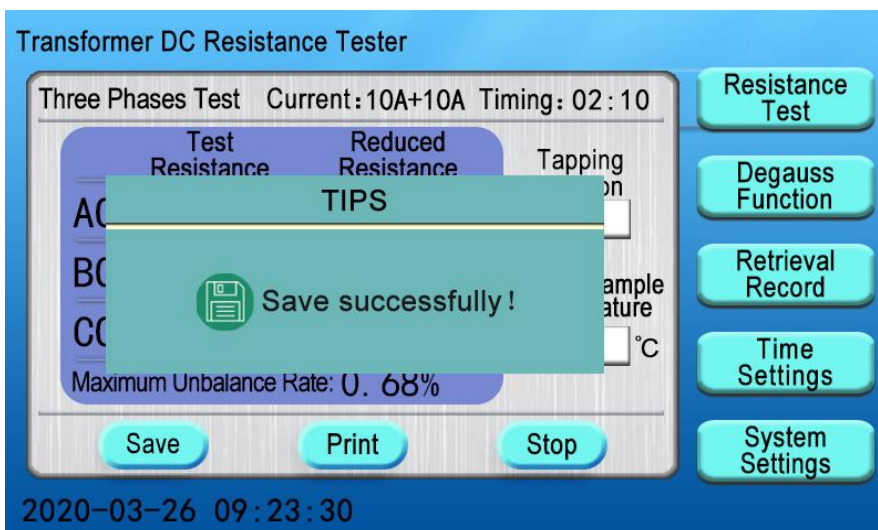

Fig. 8

After the completion of the test need to print the current data. You can click the **“Print”** button on the LCD screen of the tester; in this case, the **“Printing, Please Wait...”** prompt box will be displayed on the screen and the test data will be printed. After the printing is completed, the **“Print out”** prompt box will be displayed on the screen, as shown below:

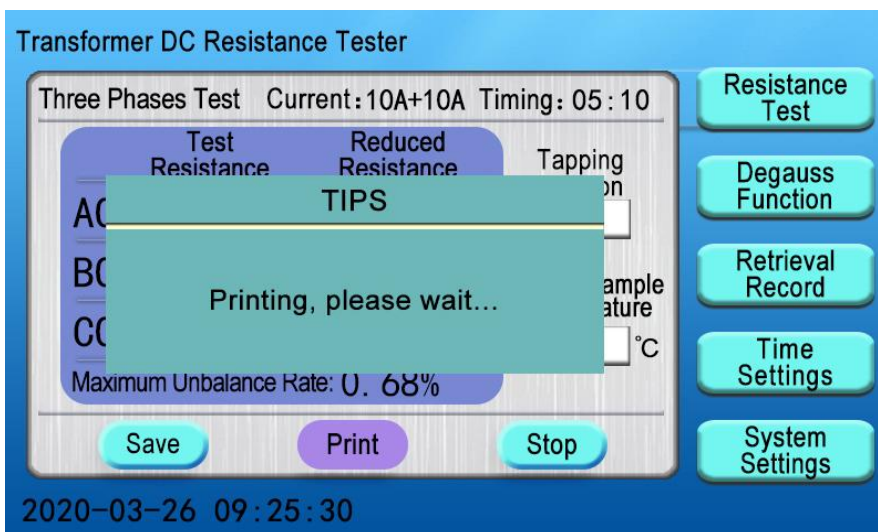

Fig. 9

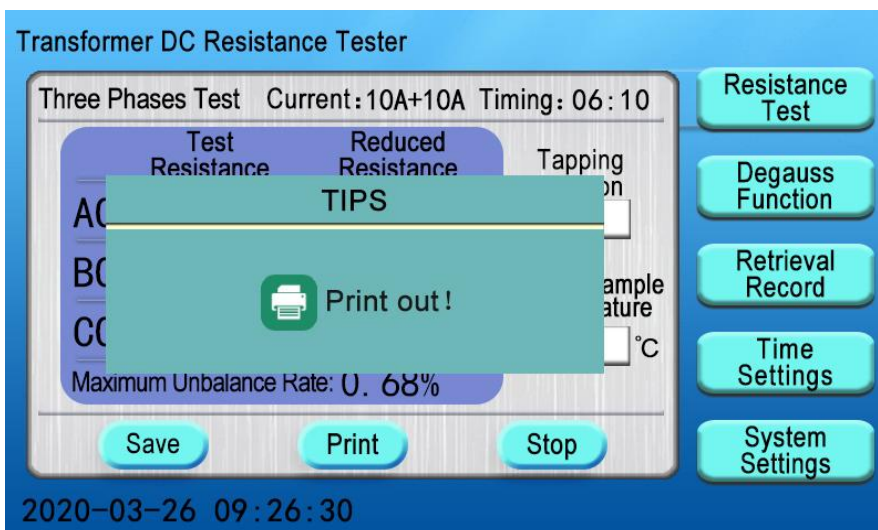

Fig. 10

After the test is completed, you can click the “**Stop**” button; in this case, the test current will be disconnected, the tester will be discharged, the “**Please do not remove the wire while discharging**” prompt box will be displayed on the LCD screen, and the audio alarm will be issued at the same time, as shown below:

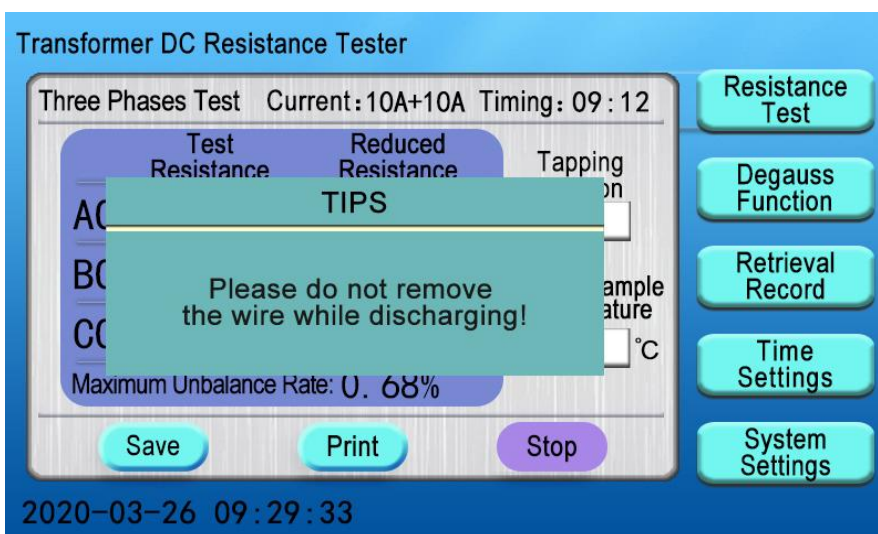



Fig. 11

After the discharge is completed, the main interface will be returned automatically on the LCD screen.

(2) **YN test:** You can select the “**YN Test**” menu on the main interface, click the  button under the current option to change the test current, click the  button under the phase option button to change the test phase, select the corresponding test current level and phase for the tested product, and then click the “**Testing**” menu; for example, you

can select 20A as the test current, and BO phases as test phases, as shown below:

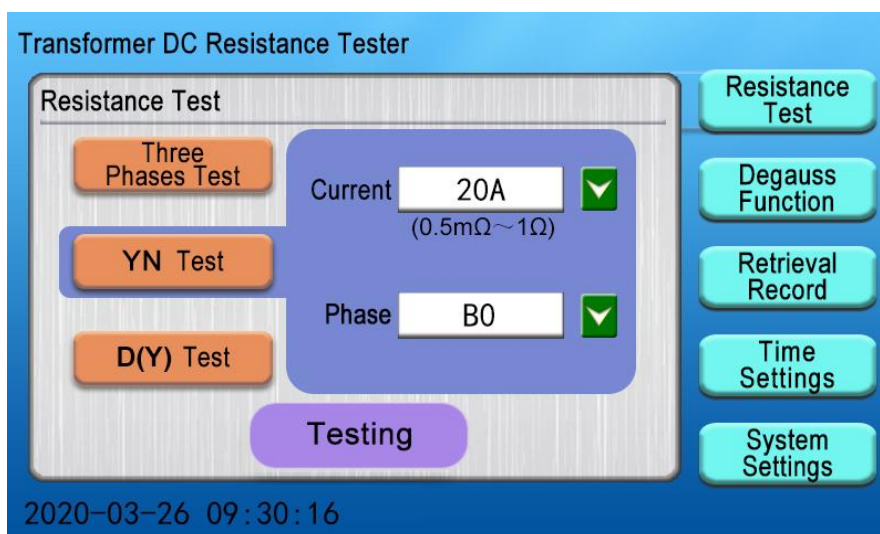

Fig. 12

The **YN test** interface will be entered on the tester, to display the current test phase and start the timing operation. During the stabilization process of the test current, you can change the Tapping Position, Tested Sample Temperature and other parameters (with the same operation steps as those in the Three Phases Test), as shown below:

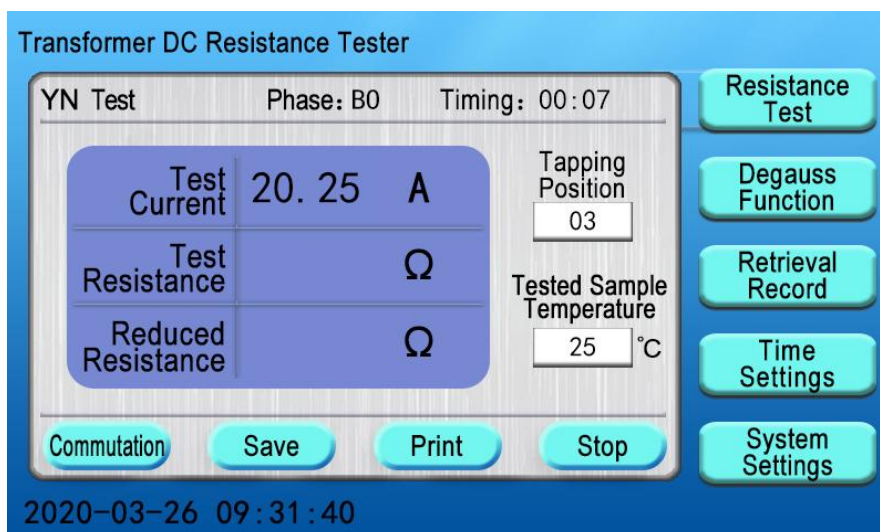

Fig. 13

After the current test phase is completed, you can click the **“Commutation”** button in the interface; in this case, the **“Please do not remove the wire while discharging”** prompt box will be displayed to stop the current phase test, and then automatically changed to the next phase for testing, as shown below:

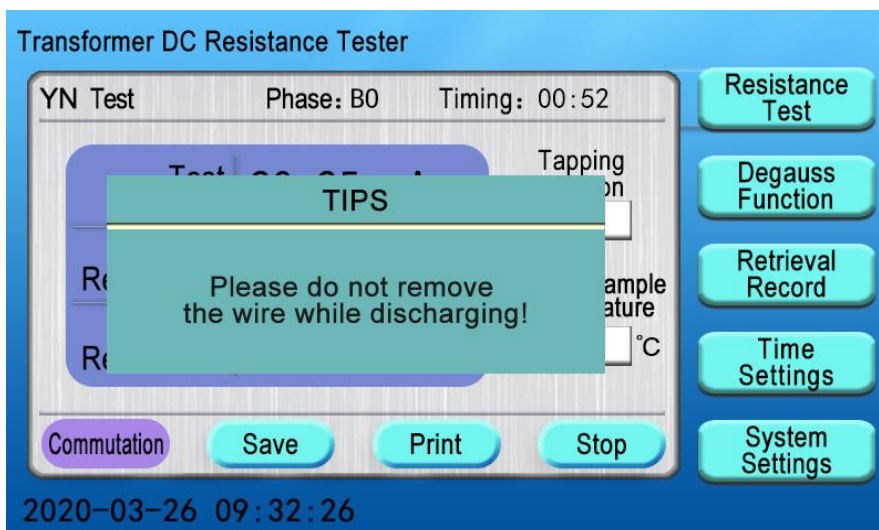

Fig. 14

The test phase in the interface will be switched to the **CO phase** automatically, the timing operation will be restarted, and the actual test current values will be displayed. After the current values are stabilized, the test resistance values and the converted ones at the set temperature will be displayed, as shown below:

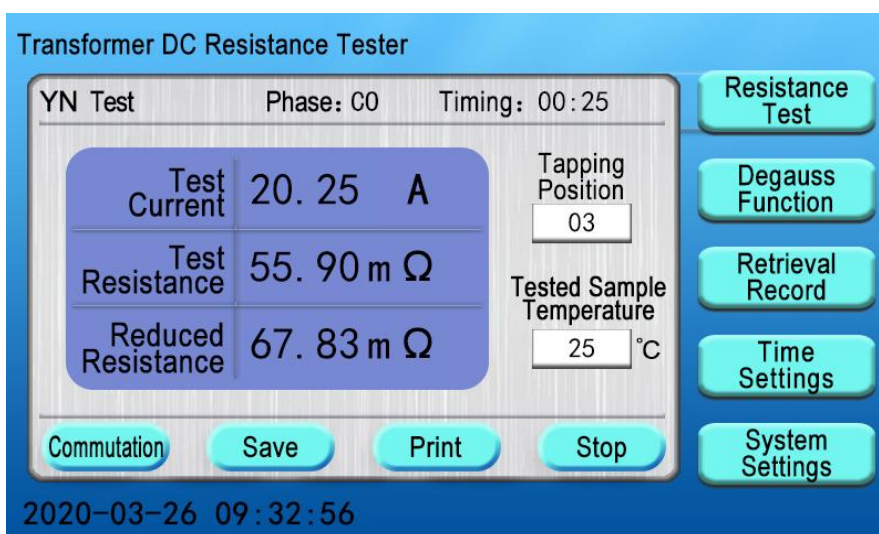

Fig. 15

Click the “**Commutation**” switch button again, the tester also shows the “**Please do not remove the wire while discharging**” prompt box to stop testing the current phase, and then automatically switch to the **AO phase** for testing, as shown below:

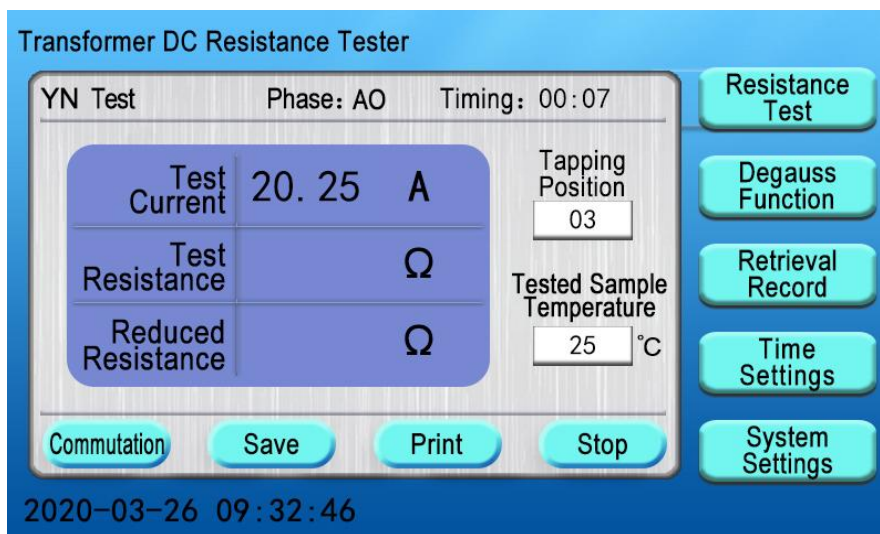

Fig. 16

The tester is testing the **AO** phase. Later, the interface shows the resistance value of **BO**, **CO**, **AO** three phases test, converted resistance value and three phases unbalance rate, as shown below:

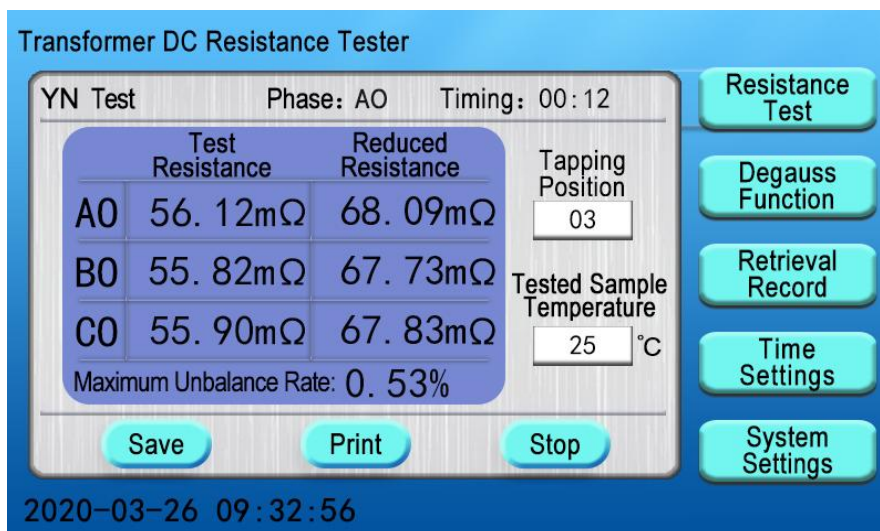

Fig. 17

The **“Save”** button is used to save the test data, and the **“Print”** button is used to print the current test data, and the **“Stop”** button is used to stop the test and issue **“Please do not remove the wire while discharging”**. After the tester is discharged, the main interface will be returned on the LCD screen (with the same operation steps as those for

the Three Phases Test).

(3) **D (Y) test**: You can select the **D (Y) test** menu in the main interface, click the button under the current option to change the test current, click the button under the phase option to change the test phase, click the button under the magnetic assist option to start or stop the magnetic assist function, select the corresponding test current level and phase for the tested product, and then click the “**Testing**” menu for the test; for example, select 10A as the test current and ab phases as the test phases, stop the magnetic assist function, and click the “**Testing**” button, as shown below:

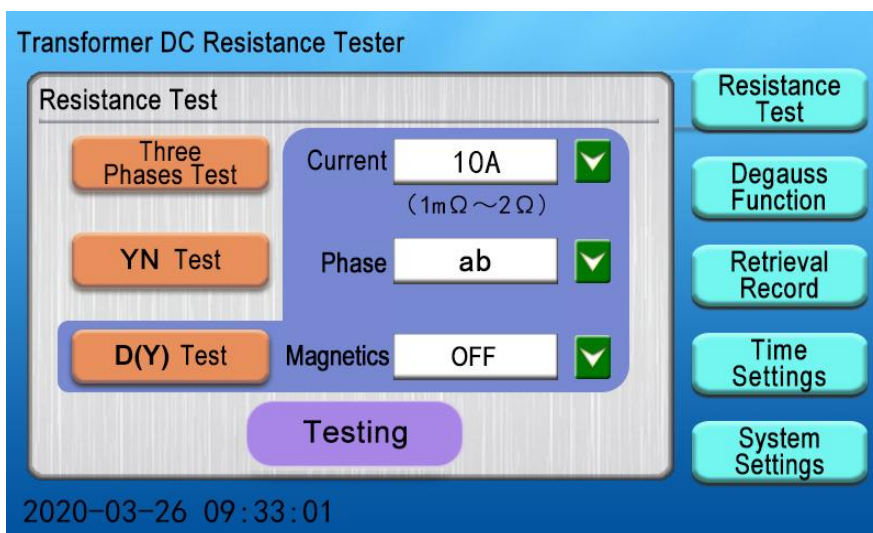

Fig. 18

The **D(Y) test** interface will be entered on the tester, to display the current test phase and start the timing operation. During the stabilization process of the test current, you can change the Tapping Position, Tested Sample Temperature and other parameters (with the same operation steps as those in the Yn Test), as shown below:

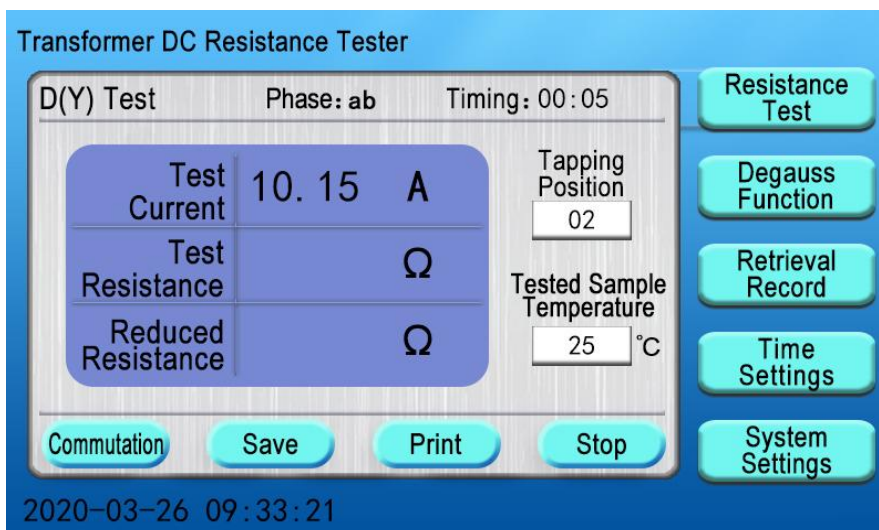

Fig. 19

After a few seconds, the test resistance values will be displayed and the converted resistance values will be calculated automatically at a fixed temperature, as shown below:

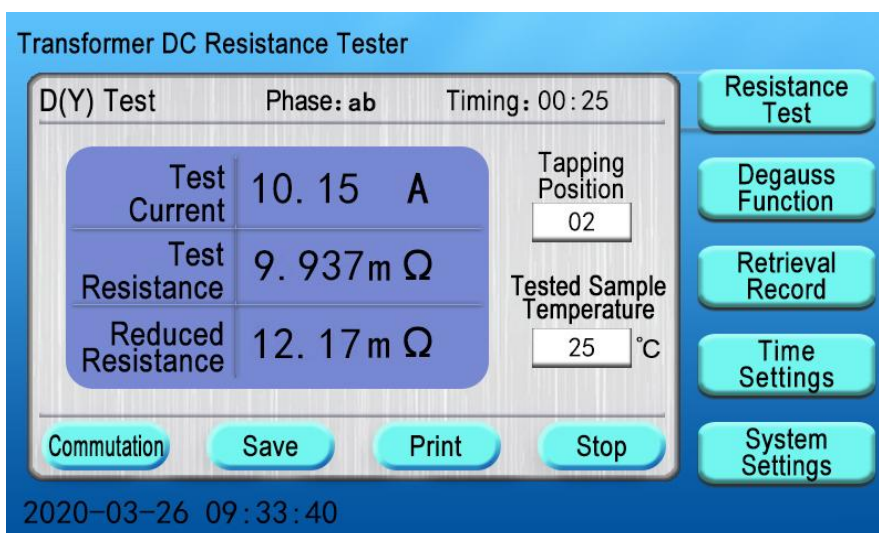

Fig. 20

After the current test phase is completed, follow the operation steps for “**Commutation**”, “**Save**”, “**Print**” and “**Stop**” items, which are the same as those for the **YN test**. The test completion interface automatically summarizes **DY** test resistance, conversion resistance and three phases unbalance rate, as shown below:

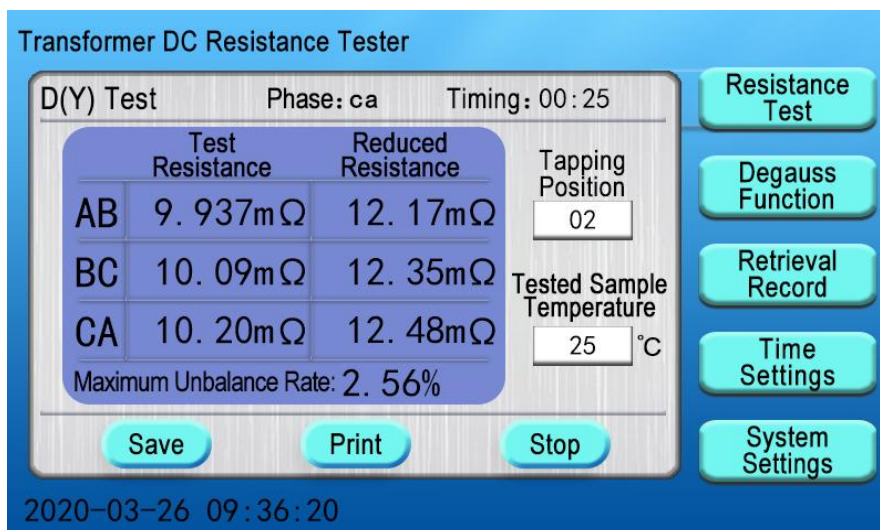

Fig. 21

After the “**Stop**” button is clicked, the tester will be discharged, and then the main interface will be returned automatically.

Note: When testing on-load tap-changing transformer or other inductive loads, please be sure to wait until the discharge alarm stops before the rewiring for the next measurement or turn off the test wires !

3) Degauss Function

You can select the “**Degauss Function**” menu on the main interface to access the internal Degauss Function interface. Based on the actual wiring conditions, you can click the button under the demagnetization phase and then click the “**Start Degaussing**” menu to start the relay for demagnetization, as shown below:

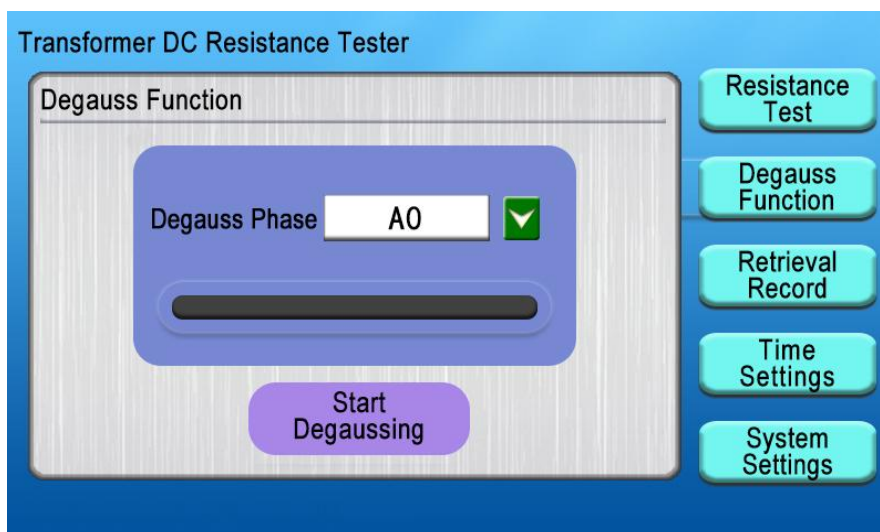

Fig. 22

After the Degauss Function is started, the demagnetization process will be displayed on the demagnetization progress bar on the LCD screen, as shown below:

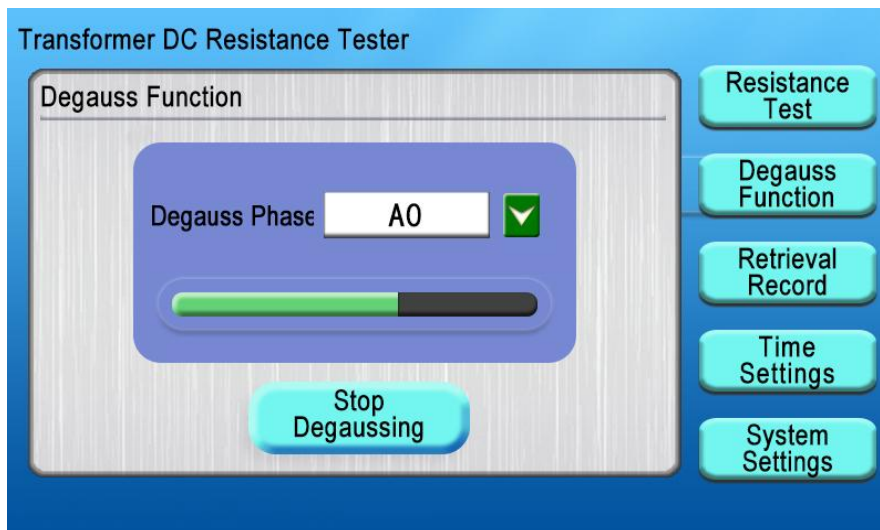

Fig. 23

During the demagnetization process, you can click the “**Stop Degaussing**” button, to display the “**Please do not remove the wire while discharging**” prompt box and then stop the demagnetization, as shown below:

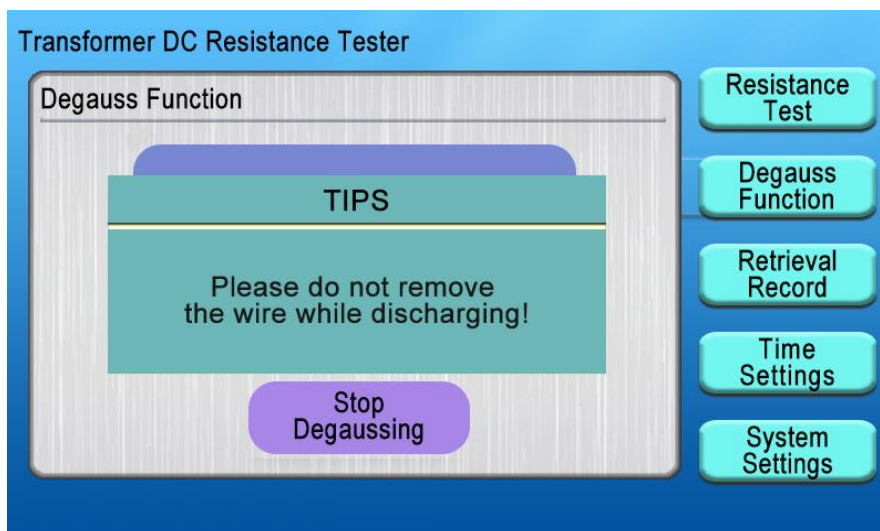

Fig. 24

After The demagnetization progress bar is completed completely and turned into the green, the “**Degaussing Completed**” prompt box will be displayed, as shown below:

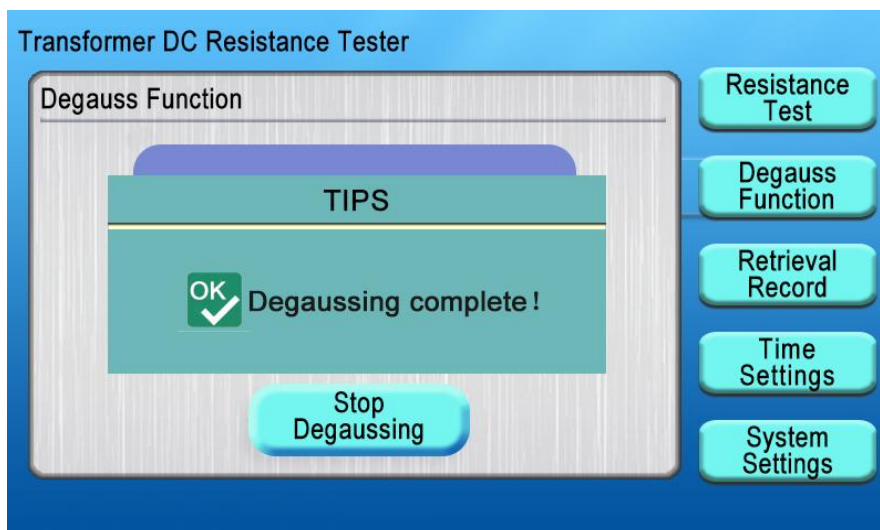

Fig. 25

4) Retrieval Record

You can select the “**Retrieval Record**” menu on the main interface, to open the internal record interface and view, print, export, delete and clear the test records saved in the tester, as shown below:

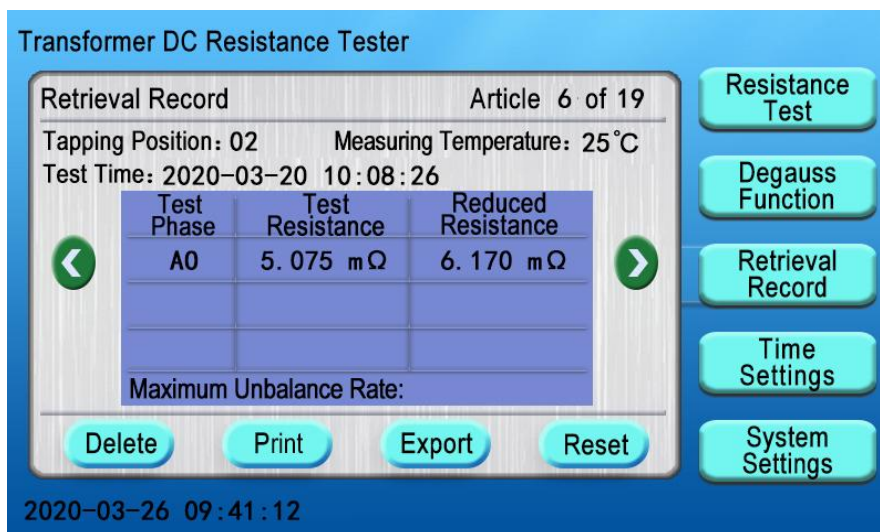

Fig. 26

Delete: Select the “**Delete**” button, to display the “**Delete Completed!**” prompt box and delete the current test record in the tester.

Print: Select the “**Print**” button, to display the “**Printing, Please Wait...**” prompt box and then print the current test record.

Export: If the “**Export**” button is selected and a U disk is not inserted in the tester, the “**Please Insert a U Sisk**” prompt box will be displayed on the screen; If the “**Export**”

button is selected and a U disk is inserted in the tester, the “Exporting, Please Wait...” prompt box will be displayed on the screen.

Reset: Select the “Reset” button, to display the “Clearing, Please Wait...” prompt box and then clear all test records.

5) Time Setting

After the tester is started and the main menu interface is displayed (Fig. 3), you can select the “Time Settings” menu, to enter the time setting interface, as shown below:

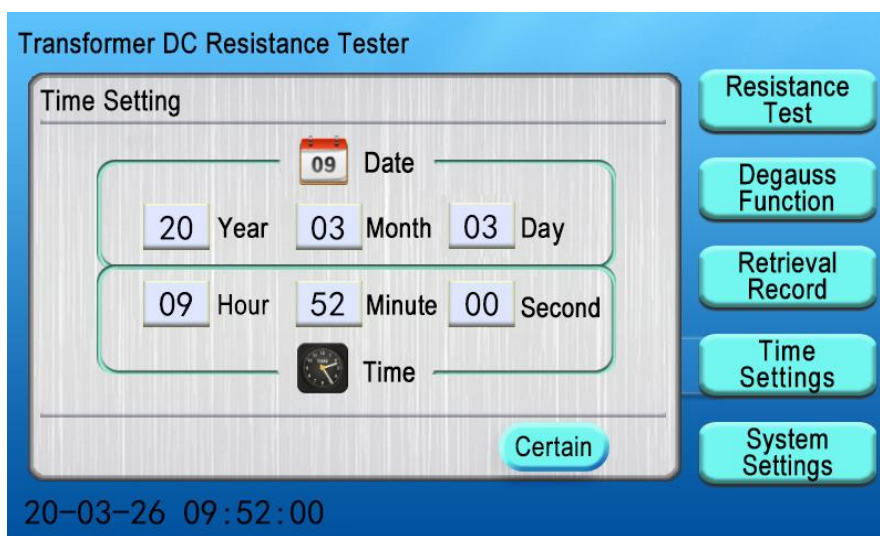

Fig. 27

You can click the prompt boxes under “Year”, “Month”, “Day”, “Hour”, “Minute”, and “Second” items to display a numeric keyboard, change the corresponding values and click the “OK” button for confirmation, so as to correct the date and time, as shown below:

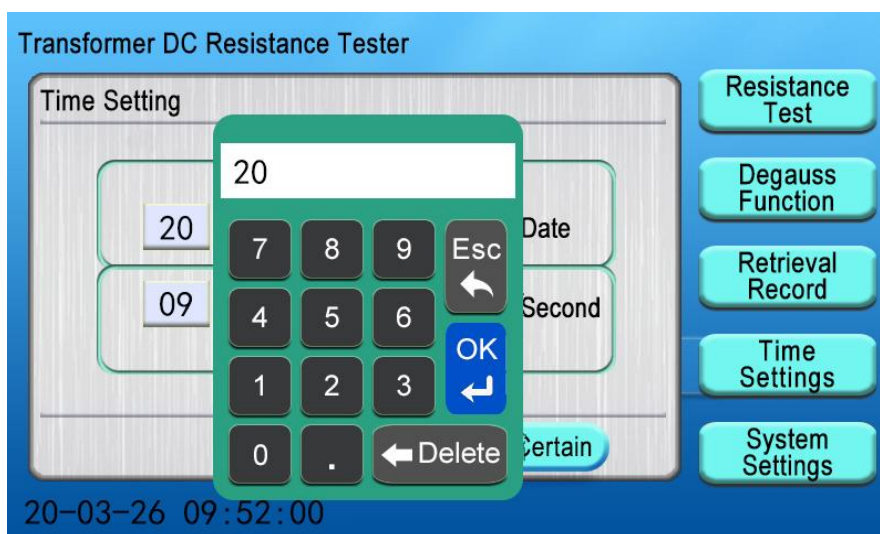

Fig. 28

After the date and time correction is completed, you can click the “OK” button to return to the main interface.

6) System Settings

After the tester is started and the main menu interface is displayed (Fig. 3), you can select the “System Settings” menu, System Settings including **Tester Setting**, **Communication Parameters**, **Internal Debugging** within three set of options, communications parameters is PC communication protocol, internal debugging is internal calibration instrument before they leave the factory. to enter the “Tester Setting” sub-interface, as shown below:

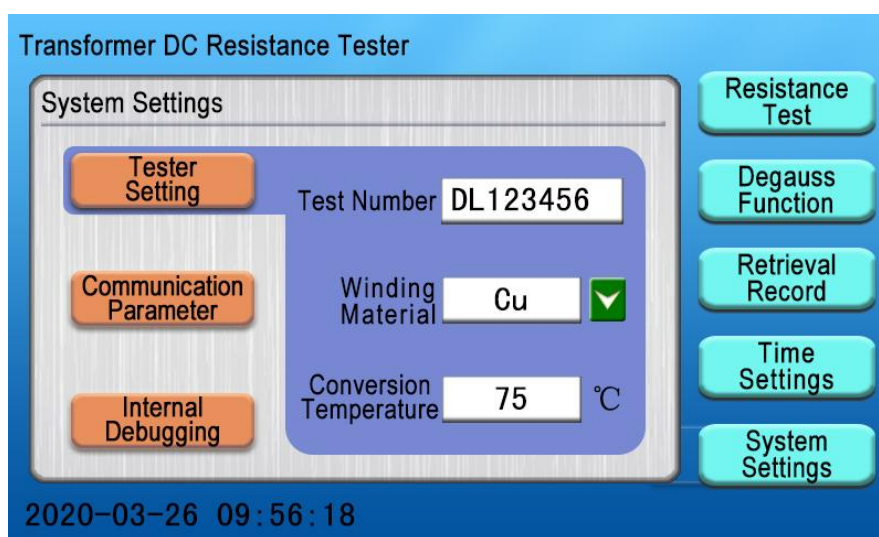

Fig. 29

Test Number: Click the dialog box under the “Test Number” item to display the **Letter Keyboard** prompt box; in this case, you can enter the factory number to identify the device under test. After the entering operation is completed, you can click the “Enter” button to save the product number. If the product number is not changed, you can select the “Esc” button on the letter keyboard, to exit and return to the setting interface;

Winding Material: Click the button at the back of the dialog box to change different options of “Cu” and “Al” in case of different temperature coefficients;

Conversion Temperature: Click the dialog box to display the prompt box on the numeric keypad. Enter the corresponding temperature value and click **OK** to save the conversion temperature (the default conversion temperature of the tester is 75°C).

VIII. Notes

Before reversing the tap connections in the test of no-load voltage regulating transformers, be sure to reset the tester, wait till the end of the discharge process and the alarm stops. Before removing the wires, be sure to wait till the discharge process completes and the discharge alarm stops.

When the three channels are used, because the initial establishment of the magnetic circuit may take longer when testing the first set of data, the stabilization time can be shortened when the tap connections are reversed.

IX. List of Complete Accessories

Name	Quantity
Transformer DC resistance tester host	1 unit
Dedicated test wires	1 set
Standard resistance	1 unit
Printing paper	2 rolls
Fuse	2 units
Grounding wire	1 unit
Power wire	1 unit